

# Characterizing the Bistable Flow, of BWR, as a Bifurcation (Pitchfork Type) in the Navier-Stokes' Equation Solution

Dr. Carlos J. Gavilan Moreno

Cofrentes NPP. Iberdrola Generación Nuclear, Paraje el Plano S/N. Cofrentes 46625. Valencia. Spain.

**Abstract**— Many nuclear power plants have undertaken power uprate processes, increasing recirculation, feed water and steam flow rates. With regards to recirculation flow, adverse scenarios, may arise where the flow varies autonomously between two values, a phenomenon known as bistable flow. Although this phenomenon is typically related to power uprate processes, some plants experience it when they reach high flow values, especially at the end of the cycle.

This study proves empirically the existence of a Pitchfork-type bifurcation in the bistable flow situation. The parameter determining bifurcation will be Flow Control Valve (FCV) position in recirculation loop. This choice is made considering that it is the only variable during recirculation loop operation, because under stable operation and constant power the remaining variables (Geometry, Combustible, Differential Core Pressure, Pump Turning Speed (r.p.m.), etc.), are considered constant.

**Keywords**— Bifurcation, pitchfork, bistable, recirculation, FCV, flow.

## I. INTRODUCTION

In 1985, an electrical power fluctuation was detected at the Leibstadt Nuclear Power Plant during startup and load tests at 100%. Loop "A" fluctuation ranged between 2.5% and 3%, whereas in loop "B" it was between 3% and 3.5%. It was concluded that recirculation flow fluctuations were caused by a bistable flow pattern in the pump discharge header.

In the year 1986, the first regulatory reference on abnormal performance of recirculation loop flows was written. (USNRC IE IN No. 86-110). This document determines that fluctuations vary from station to station and even within the loops of the same unit. This document also concludes that this phenomenon does not impact safety.

In July 1988, General Electric issued a letter (General Electric Energy, Nuclear SIL No. 467) establishing that the problem affects Boiling Water Reactors BWR from

generation 3 to 6 and is detected at the manifoldsof pipes supplying jet pumps. (Figure 1).

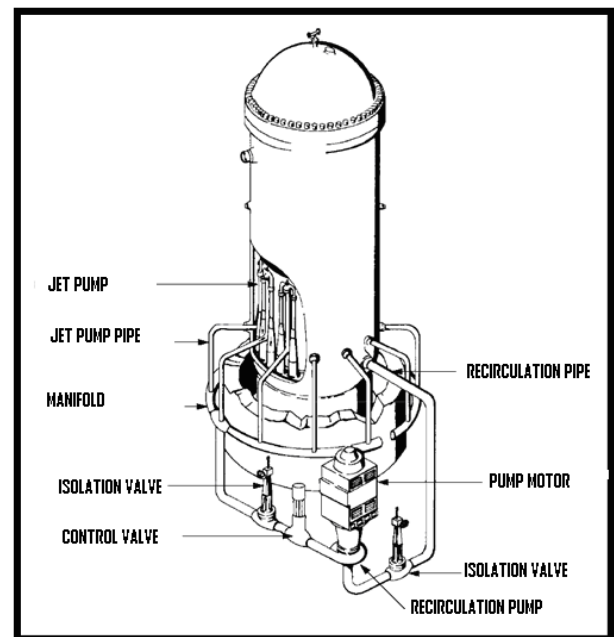

Fig.1: Recirculation loop scheme in a Generation 6 BWR.

In Japan, between 1986 and 1989 a group of researchers applied various hydraulic models to replicate (Miura et al 1986), characterize (Miura et al 1987) and propose compensatory measures (Ohki, A. et al 1988) to the bistable flow.

In 2006, a bistable flow phenomenon analysis was presented at Laguna Verde nuclear power plant in México. (Nuñez Carrera et al., 2006).

After 2008, new research (Gavilan Moreno, C.J. 2008), concluded that the bistable flow can be described as a noise-induced transition mechanism (Horsthem & Lefever (2005)). In this theory, noise is identified as flow turbulence under high Reynolds values.

In 2009, bistable flow analyses continued, using mathematical techniques such as wavelets (Nuñez-Carrera et al., 2009) and codes for fluid dynamics. These were used to replicate the results of hydraulic models from the 80s. (Gavilan Moreno, C.J. 2009).

In 2011, a new 3D CFD model confirmed the existence of two states and the non-convergence of the stable condition at specific Reynolds values. (Gavilán Moreno, C.J. 2011)

In line with the above mentioned in this section, the state of the art in bistable flow can be summarized as Unpredictable, fluctuating hydraulic phenomenon, characterized by high turbulence.

In the following paragraphs, the Pitchfork type bifurcation concept is introduced and justified.

Supposed a dynamic system, a bifurcation occurs when a small smooth change made to the parameter values of a system causes a sudden qualitative or topological change in its behavior. The name “bifurcation” was first introduced by Henri Poincare in 1885, in the first paper in mathematics showing such a behavior.

It is normal to divide bifurcations into two classes: Local bifurcations and Global Bifurcations. A local bifurcation occurs when a parameter change, causes the stability of equilibrium or fixed point to change. Examples of local bifurcation include: Saddle-node bifurcation, Transcritical bifurcation, Pitchfork bifurcation, Hopf bifurcation and Neimark-Sacker bifurcation. In continuous dynamical systems described by Differential Equations (DE)—i.e. flows—pitchfork bifurcations occur generically in systems with symmetry. Pitchfork bifurcations have several types – supercritical, transcritical and subcritical. Normally solving the DE’s can be found that, for depending on some parameters values, the system has one stable equilibrium point, or an unstable point or two stable equilibria points. This last status is the key to identify the bistable flow with the pitchfork bifurcation.

The recirculation system, of a BWR, is a hydraulic system, whose behavior is described by the equation of Navier Stokes which can be seen in Equation (1). The recirculation system is a symmetric system. So the solution of the Partial Derivatives Equation (PDE), could present Pitchfork type bifurcation. A deeper analysis is done to justify the bifurcation.

$$\frac{D\vec{u}}{Dt} = \vec{F} - \nabla P + \frac{\mu}{\rho} \left( \frac{1}{3} \nabla (\nabla \cdot \vec{u}) + \nabla^2 \vec{u} \right) \quad (1)$$

The equation (Eq. 1) has the following vectors:  $u$  (speed),  $P$  (pressure),  $\mu$  (viscosity) and  $\rho$  (fluid density). Since the system has a constant section and there are no fluid sumps or sources, integrated fluid speed is similar to the scalar flow value. Likewise, pressure variation only depends on FCV opening. Thus, Equation (1) can be reformulated as Equation (2):

$$\frac{dq}{dt} = F(q, A) \quad (2)$$

Where  $q$ =flow rate and  $A$ = FCV position.

Additional information regarding this equation and system is:

- The fluid is in an incompressible state.
- The fluid is at a constant temperature.
- The system responds with an equation similar to  $q=q(A)$ .
- Primary derivatives are determined by Equation (3), with notation and secondary derivatives being simplified in Equation (4):

$$\begin{aligned} \frac{\partial F(q,A)}{\partial q} &= F_q \quad y \quad \frac{\partial F(q,A)}{\partial A} = F_A \quad (3) \\ \frac{\partial F^2(q,A)}{\partial q^2} &= F_{qq} ; \quad \frac{\partial F^2(q,A)}{\partial A^2} = F_{AA} \quad y \quad \frac{\partial F^2(q,A)}{\partial qA} = F_{qA} \quad (4) \end{aligned}$$

The stability analysis results from establishing a null time derivative. In other words, if the system does not change and FCV opening and other conditions do not vary, flow remains the same. Mathematically, this is seen in equation (5).

$$\frac{dq}{dt} = 0 = F(q, A) \quad (5)$$

So, analyzing bifurcations in Equation (4) is the same as analyzing specific F curve points ( $q, A$ ) on the FCV opening-flow plane. Considering these parameters, the points that confirm the equation (7) are considered unique and can be classified as follows: Regular Points, Regular Inflexion Points, Unique Points, Double Curve Point, Double Inflexion Points and Peak Points.

The Double Curve Point generates two solutions and a curve running through the unique point that has two slopes. Although there are multiple potential shapes, the one selected provides two stable results as it is coherent with bistable conditions.

In the case of double point bifurcation, there is an equilibrium point with two curves and two different slopes. (Ioos, G; Joseph, P.D. 2001). Curve tangents conform to Equation (6)

$$\begin{bmatrix} \frac{dq^1}{dA} \\ \frac{dq^2}{dA} \end{bmatrix} = \begin{bmatrix} q_A^1 \\ q_A^2 \end{bmatrix} = - \frac{F_{qA}}{F_{qq}} \begin{bmatrix} 1 \\ 1 \end{bmatrix} - \sqrt{\frac{D}{F_{qq}}} \cdot \begin{bmatrix} 1 \\ -1 \end{bmatrix} \quad (6)$$

Where “D” is determined by equation (7):

$$D = F_{qA}^2 - F_{AA} \cdot F_{qq} \quad (7)$$

Slope analysis results from analyzing the value of parameter D. If  $D < 0$ , there are no real tangential lines on the point, which means the existence of a double point and two slopes can only be justified when  $D > 0$ . In this case, if specific concepts are renamed, flow curve slopes in relation to FCV opening are determined by equation (8):

$$\frac{dq}{dA} (A_0) = q_A (A_0) = -K_1 \pm \sqrt{K_2} \quad (8)$$

For this equation to be true, the condition of  $F_{qq}$  not being null must be satisfied. The other condition for conformance to  $D > 0$  is the verification of equation (9):

$$F_{qA} > \sqrt{F_{AA} \cdot F_{qq}} \quad (9)$$

To conclude this theoretical development, the requirements for existence of a double point bifurcation are mathematically confirmed because  $F_{qq}$  is not null and  $D$  can, under specific conditions, be higher than zero. And as the solution existence theorem says, if  $F(q,A)$  is continuous, then at least one solution of the Equation 1 exist. (Existence and not uniqueness).

## II. METHODOLOGY

The methodology used in this study has foursteps. The Analysis is done based on recorded recirculation flow rate (%) and FCV position (%) data for a full 24-month cycle at an operating station.

S1. Determine the curve for recirculation flow (%) vs. FCV position (%). Using the data from the plant computer a third order polynomial is fitted with a 99.99% of confidence interval. The polynomial order is determined by the recirculation system designer. This step will demonstrate that a continuous and derivable function (Flow rate (%)-FCV position(%)) exists. This is a prerequisite to have a bifurcation.

S2. The error is calculated as difference between fitted curve values and real data for a given FCV position (%). (Equation 10)

$$\text{Error(FCV Position)} = \text{Measured Flow(\%)} - \text{Calculated Flow(\%)} \quad (10)$$

The analysis, of the equation (10) results, is the starting point of the bifurcation study.

S3. Taken the FCV (%) error-position data, Figure 3 and Equation (10), the bifurcation map is built. The bifurcation start point and two branches that characterize the pitchfork bifurcation are identified. The FCV position is considered as bifurcation parameter and will be the abscissa axe.

The bifurcated parameter is the recirculation flow rate. To enhance the graphic representation, a linear conversion will be done. So instead of recirculation flow rate (%) analysis, the error (Eq. 10) analysis will be done. The analysis will be as follows:

- A time period, in which the FCV position (%) is stable and constant, is selected. TheFCV position (%) values selected for this task are 29, 62, 62.3, 63, 64, 68, 72, 77 and 82%. The reason is

because the FCV position is not continuous nor a differentiable as time function.

- New time series are recorded. Now, the time between records is 1 s. The time series are again, recirculation flow rate (%) and FCV position (%).
- Using equation 10 and table 2, the error is calculated from the recirculation flow rate time series built from previous step.
- A histogram with the error data is built. New variable named  $\tau$  (tau) is built. The value of  $\tau$  will be the error value in which the histogram has a maximum (most expected value) but if there are two maximums, then  $\tau+$  and  $\tau-$  will be recorded.
- Based on  $\tau$  ( $\tau+$ ,  $\tau-$ ) and FCV position (%) the bifurcation map is built.

### 2.1. Development

FCV position (%) and recirculation loop flow rate(%) are interrelated time series with which a bifurcation diagram will be developed. This approach is aligned with previous works which use time series as a starting point contributing to determinate bifurcation states. (Bagariano, E. et al, 1998 & 2000). It is also important to take into consideration that used time series are noisysignals.

The analysis of recirculation loop flow signal under bistable conditions has a number of phases aimed at determining flow signal features. Once this information is obtained, the entire system is analyzed, with a special focus on the relationship between recirculation loop flow rate and FCV position. The idea, suggesting bifurcation existencewill appear at this point.

#### 2.1.1. Flow control Valve (FCV) position (%)-Flowrate(%) curve analysis (S1).

The studied NPP is a BWR 6 reactor, has two recirculation loops, each with its own flow control valve (FCV). (Figure 1)Figure 2shows records during a 24-month operating cycle, of the recirculation flow rate (%) and the FCV position (%).

A morphological analysis of the points cloud reveals that after a 60% opening approximately, the cloud begins to widen and after 62% it has a new width which remains constant until the end.

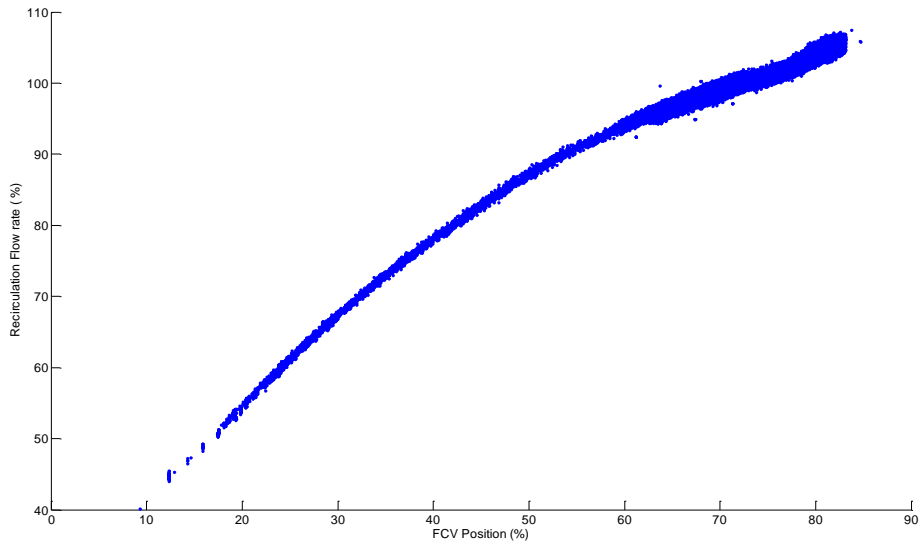

Fig.2: Operational points plot. (Recirculation Flow rate % vs. FCV position%).

The system designer fitted a third degree polynomial for the flow equation based on FCV position. This fit, with a confidence level of 99.999%, provides the coefficients shown in table 2.

Table.2: Polynomial coefficients for the theoretical curve fitted with actual data.

	$Calculated\ Flow\ (\%) = a * (FCV_{POS})^3 + b * (FCV_{POS})^2 + c * (FCV_{POS}) + d$			
	a	B	c	d
FLOW RATE-FCV POSITION ADJUSTMENT	$6.5801 \cdot 10^{-5}$	-0.0188	2.1469	18.5307

So it is confirmed that there is a continuous and derivable function that establish a relationship between flow rate (%) and FCV position (%). Based on that, the existence of Navier-Stokes' equation solution is clear, but the uniqueness is not ensured. So the bifurcation is possible.

**2.1.2. Error analysis (S2).**

Error (Equation (1)) is established as the difference between the measured flow value (%) and the fitted curve value, as seen in table 2 parameters.(Figure 3.)

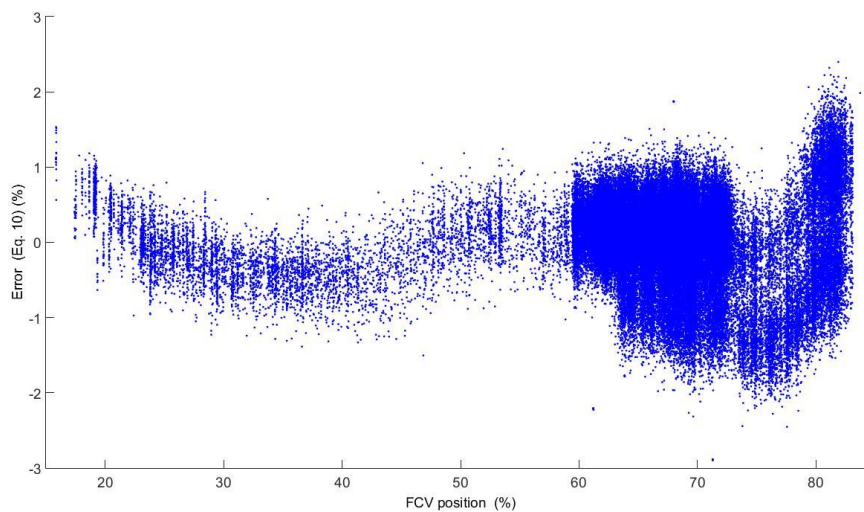

Fig.3: Error vs FCV position (%).

Figure 3 confirms the idea that there is some kind of phenomenon is changing flow patterns when FCV position is 60% or above. This is because the error value, changes in shape and values. Error varies from about 0% with a  $\pm 0.5\%$  band to a  $\pm 1.5\%$  band. Even for values exceeding 80%, there is a clearly strong, differentiated bias with regards to flow behavior at this FCV position. A histogram is created to analyze the overall error. Figure 4 shows the Error (Equation 1) histogram. The histogram

when analyzed leads to the conclusion that the average error tends to positive values and with a certain level of asymmetry for negative values. The histogram showed in figure 4, could be explained as the superposition of two normal distribution functions. The principal one has an expected value or maximum on 0.1 and the secondary has the expected value or maximum about 1%.

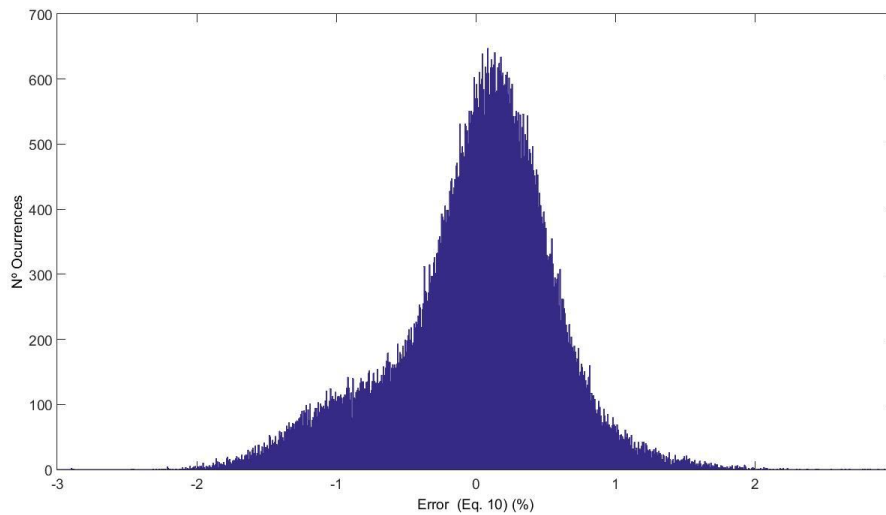

Fig.4: Error (Equ. 10) histogram

## 2.2. Bifurcation Characterization

The existence of a bifurcation structure will be demonstrated in this phase through the selection of FCV position as the bifurcation parameter because it is the only one variable parameter in the system.

This section is focused on characterizing the pitchfork-type bifurcation for recirculation flow under bistable conditions. The coordinate parameter will be tau ( $\tau$ ), whereas the abscissa is the FCV position (%). The initial bifurcation point will be FCV position at 62, 3 and  $\tau=0$ . The FCV position and tau values can be seen on table 3.

Table.3: tau and FCV position (%) values.

FCV Position (%)	Tau (-)	Tau (+)	Reference figure
30,3	-0.577	-0.577	
62,3	0	0	Figure 5
63,75	-0.674	0.293	
64	-0.675	0.294	
66	-0.728	0.306	
68	-0.785	0.313	
72	-0.863	0.256	
77,5	-0.955	0.287	Figure 6
82	0	1.3	

The graphical representation of values in table 3 is seen in figures 5 and 6. These values are used to create the bifurcation map. (Figure 7).

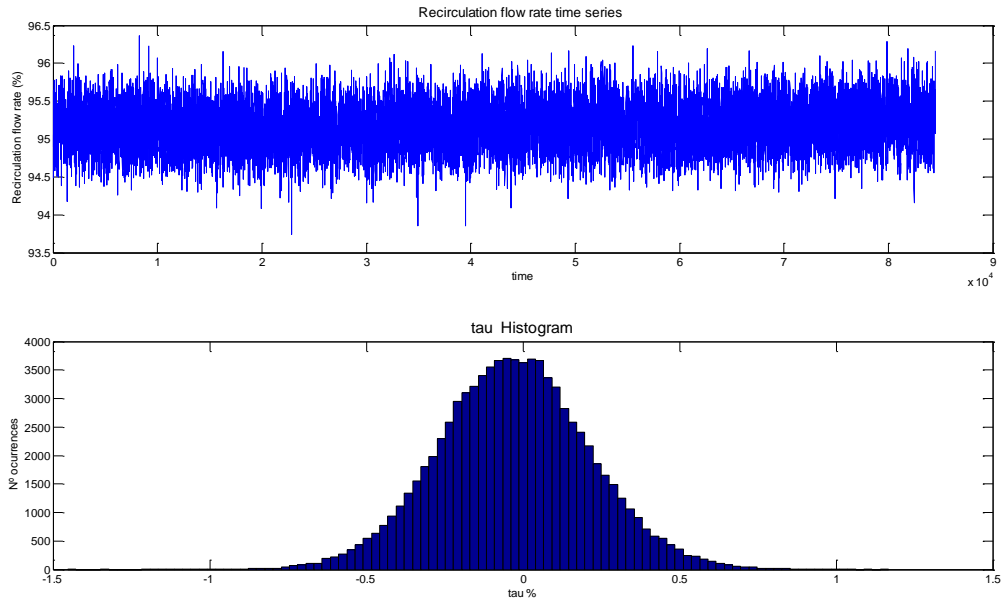

Fig.5: Recirculation flow evolution with FCV position value at 62,3 %.

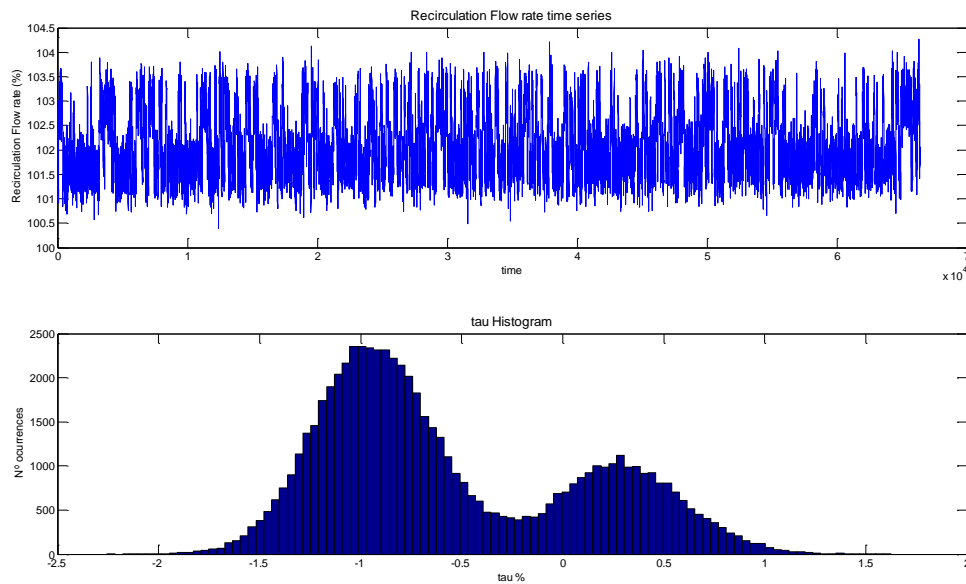

Fig.6: Recirculation flow evolution with FCV position value at 77,5 %.



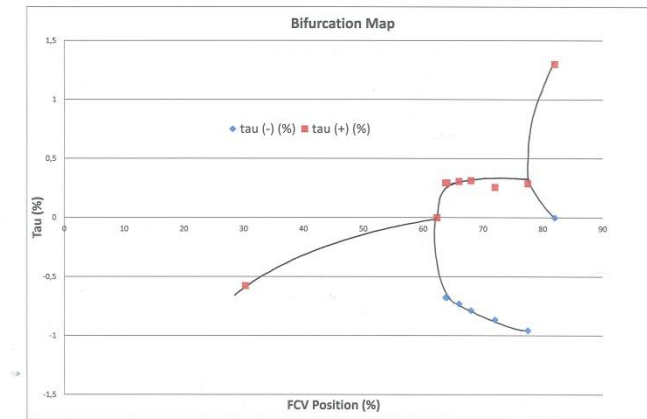

Fig.7: Taubifurcation diagram. Continuous lines represent the values of stable and expected solutions (feasible)

The data in table 3 is used to create a set of points on plane FCV position- $\tau$ . The result is seen in the graph of figure 7. An analysis of the graph in figure 8 reveals the evident existence of bifurcation on point (62,3,0), which corresponds to a bifurcation of the pitchfork-type . Deeper analysis shows that there are two consecutive bifurcations and two bistable states. The first bistable state is limited to FCV position values ranging between 62,3 and 77 (pitchfork bifurcation), whereas the second bistable state occurs when FCV position values are larger than 77 (secondary pitchfork bifurcation). All the bifurcation analysis and results about  $\tau$  are applicable to recirculation loop flow rate, because  $\tau$  is a variable linearly dependent of recirculation flow rate (%). So the recirculation flow rate has the same bifurcation map, than  $\tau$  .

### III. RESULTS ANALYSIS

In section 2.2 a bifurcation diagram is created in response of the behavior of recirculation loop in a BWR6 unit, which is the system under analysis.

The existence of bistable flow is proven as a physical reality of the mathematical bifurcation concept. However, it is necessary to relate flow states with mathematical states and their physical meaning. This interpretation is based on the results of this work and those of the hydraulic model (Miura et al, 1986, 1987) and computational fluid flow models (CFD). (Gavilán Moreno, C.J. 2009).

The recirculation flow rate can have three stable states, grouped in twos. The first two states, corresponding to FCV position values between 62.3% and 77%, are defined by the vortex dynamics of flow adaption in the so-called cross-piece. These states cause the following effects:

Vortex formation on the side legs of the manifold, in normal operation.

The newly formed vortexes cause flow to take two forms: one for direct inlet at high flow and the other for helical current at low flow. (Figure 8, Low Flow Pattern and High Flow Pattern)

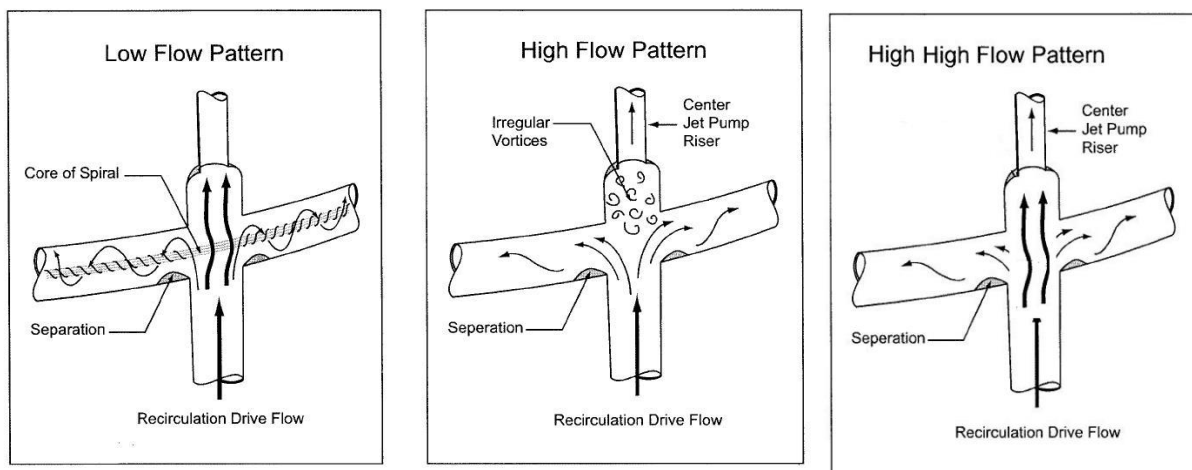

Fig.8: Recirculation loop cross-piece flow conditions for first bifurcation.

In the first flow shape, pressure loss is as designed and flow is quite similar to its theoretical value (Figure 8 High Flow Pattern). In the second flow shape, pressure loss is higher since helical flow has more internal fluid friction and pipe wall friction, causing flow to be lower (Figure 8. Low Flow Pattern).

The next bistable scenario occurs when FVC position is 77%. In this case, flow equals rated values and some slightly higher (1%). In this state, flow takes two shapes: one of direct inlet at high flow (coinciding with the former high flow Pattern) and the other free of central connection vortices (which are dragged by the high flow), hence reducing internal friction and enhancing flow. (Figure 8 High High Flow Pattern).

#### IV. CONCLUSIONS

The conclusions of this work are the following:

The bistable flow is a real flow situation in symmetric dynamic systems. The recirculation flow rate has two main values, but the FCV position just one.

The control system is not creating the bistable situation, because there is no variation of any parameter. There is no anomalous behavior of the recirculation system, because the real curve of recirculation loop flow rate vs FCV position fits very well with the theoretical one.

The Navier Stokes fluid flow equation, formally, allows and justified the pitchfork type bifurcation. There are situations where the solution, of the Navier Stokes equation, is double, so this equation has two solutions that comply with the system characteristics and boundary conditions.

A bifurcation map has been built, and the bifurcation is demonstrated. There are two bifurcations one at 62,3% FCV position and other at 77% of FCV position. Both of them are pitchfork type bifurcations.

The mathematical and real bifurcation has been correlated with the fluid flow behavior in the recirculation loop. More exactly the bifurcation is correlated with the fluid flow behavior in the crosspiece and the turbulence regime inside.

#### REFERENCES

- [1] USNRC IN No. 86-110. (United States Nuclear Regulatory Commission) "Anomalous behavior of recirculation loop flow in jet pump BWR plants", Washington. December 1986
- [2] General Electric, Nuclear SIL.467 (1988) "Recirculation System bi-stable flow in jet pump BWRs".
- [3] Miura et al. (1986) "Unstable Phenomenon in Flow through a Pipe system with a cross pipe. (1st report, Generation of flow instability and its condition)" Journal of Japan Society of Mechanical Engineers, No 86-127B, pp 35-39.
- [4] Miura, S. et al (1987) "Unstable Phenomenon in Flow through a Pipe system with a cross pipe. (2nd report, The influence of the branching discharge ratio and structural factor of a pipe upon the unstable discharge phenomenon)" Journal of Japan Society of Mechanical Engineers, No 87-1251 B, pp 1067-1610.
- [5] Ohki, A. et al (1989) "Unstable Phenomenon in Flow through a Pipe system with a cross pipe. (3rd report, Investigation of flow stabilizing structure of a pipe for the unstable discharge phenomenon)" Journal of Japan Society of Mechanical Engineers, No 88-1677 B, pp 3040-3043.
- [6] A Nuñez Carrera, E. Martínez-Mendez, G. Espinosa Paredes, Analyses of the bistable flow phenomenon at Laguna Verde Nuclear Power Plant: Proceedings of the 2006 International LAS/ANS Congress of Buenos Aires (in Spanish).
- [7] Gavilán Moreno, C.J. (2008) "Analysis and simulation of the flow signal in the recirculation loop of a nuclear power station during a bistable flow event." Nuclear Engineering and Design.
- [8] Horsthemke & Lefever (2005). "Noise Induced Transitions". Ed. Springer series in Synergetics.
- [9] Nuñez-Carrera, A; Prieto-Guerrero, A; Espinosa-Martínez, E.-G; Espinosa-Paredes, G. (2009) "Analysis of a signal during bistable flow events in Laguna Verde Nuclear Power Station with wavelets techniques" Nuclear Engineering and Design. Vol. 239, Iss. 12, pp. 2942-2951.
- [10] Gavilán Moreno, C.J. (2009) "Hydraulic Study on recirculation loops using computational fluid dynamics (CFD). Design optimization and turbulence reduction" Nuclear Engineering and Design. Vol. 239, Iss. , pp. 434-441.
- [11] Gavilán Moreno, C.J. (2011) "The Bistable flow in a nuclear Power Plant. A bifurcation in the fluid flow in the recirculation loop, modeling and simulation" Proc. Bifurcation in Fluid Dynamics. CIMNE. Barcelona
- [12] Poincare, H. (1885) "L'Equilibre d'une masse fluide animée d'un mouvement de rotation" Acta Mathematica, T.7 pp 259-380.
- [13] Ioos, G; Joseph, D.D. (1997) "Elementary stability and bifurcation theory". Ed. Springer.
- [14] Bagarinao, E. et al. (1998) "Generalized one-parameter bifurcation diagram reconstruction using time series" Physica D, Vol. 124, pp. 258-270.
- [15] Bagariano, E. et al. (2000) "Reconstructing Bifurcation diagrams of dynamical systems using measured time series" Method Inform. Med, Vol. 39, pp. 146-149.